







Machine	Explode	Code	Description
CC025-A Waring Food Processor (Light Duty Use)	1		Small Pusher
CC025-A Waring Food Processor (Light Duty Use)	2		Large Pusher
CC025-A Waring Food Processor (Light Duty Use)	3		Bowl Cover
CC025-A Waring Food Processor (Light Duty Use)	4		Bowl
CC025-A Waring Food Processor (Light Duty Use)	5		S Blade
CC025-A Waring Food Processor (Light Duty Use)	6		Disk Stem



032288

2mm - 5/64" Slicing Disc

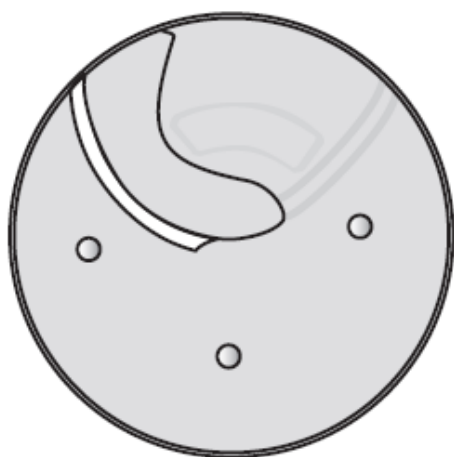
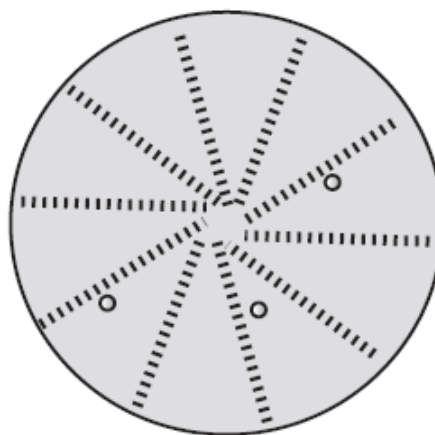

032280

2mm - 5/64" Grating Disc

Machine	Explode	Code	Description
CC025-A Waring Food Processor (Light Duty Use)	032288	AD366	2mm - 5/64" Slicing Disc
CC025-A Waring Food Processor (Light Duty Use)	032280	AC987	2mm - 5/64" Grating Disc

Discs Not On Diagram

Machine	Explode	Code	Description
CC025-A Waring Food Processor (Light Duty Use)	N/A	AC985	4mm Grating/Shredding Disc
CC025-A Waring Food Processor (Light Duty Use)	N/A	AC986	4mm Slicing Disc
CC025-A Waring Food Processor (Light Duty Use)	N/A	AD787	3mm Slicing Disc
CC025-A Waring Food Processor (Light Duty Use)	N/A	AD788	6mm Slicing Disc
CC025-A Waring Food Processor (Light Duty Use)	N/A	AD790	3x3mm Julienne Disc
CC025-A Waring Food Processor (Light Duty Use)	N/A	AD791	6x6mm French Fry Disc

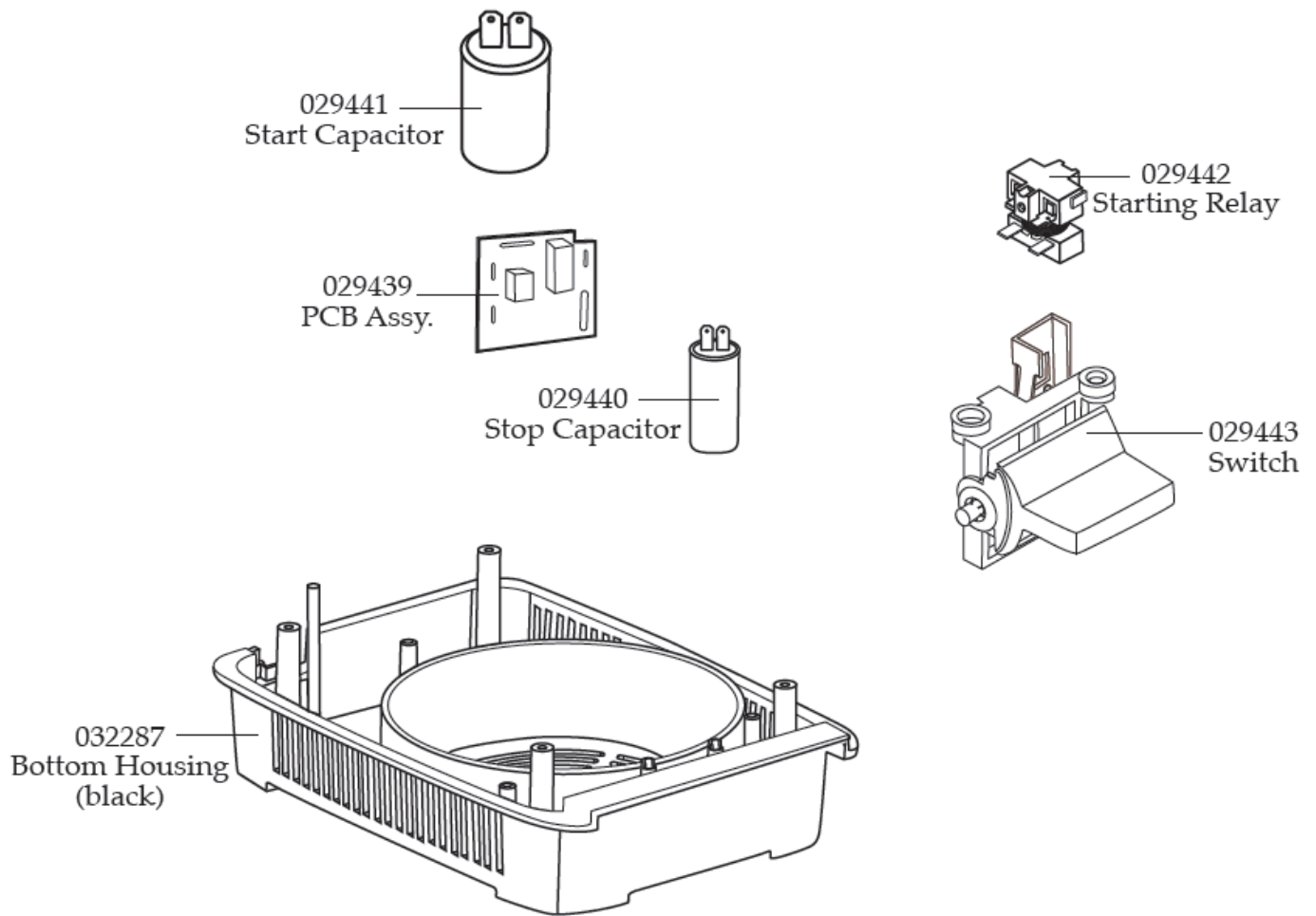

Machine	Explode	Code	Description
CC025-A Waring Food Processor (Light Duty Use)	029441		Start Capacitor
CC025-A Waring Food Processor (Light Duty Use)	029442		Starting Relay
CC025-A Waring Food Processor (Light Duty Use)	029439		PCB
CC025-A Waring Food Processor (Light Duty Use)	029440		Stop Capacitor
CC025-A Waring Food Processor (Light Duty Use)	029443		Switch
CC025-A Waring Food Processor (Light Duty Use)	032287		Bottom Housing